

# KIT/DH-PFM378-B125-CB/DH-SD6C3432XB-HNR-AGQ-PV/DH-PFB301C/PFA111

## Integrated Solar Monitoring System(Without Lithium Battery)



### System Overview

Integrated solar monitoring system (without lithium battery), all in one design, using 4G to transfer monitoring data and solar to power, which is easy/quick to install and can save wiring to the greatest extent, includes three parts: 4G network camera, integrated solar power system and camera's mounting bracket, which is more convenient for sale, order and transportation.

The integrated solar power system, integrating solar panels, maximum power point tracking (MPPT) charging controller and mounting brackets, provides stable power supply for the front-end data acquisition system—4G network camera through high conversion charging device. It is compact, portable, easy to install, disassemble and maintain compared with conventional system.

Designed with Starlight technology and 1/2.8" CMOS, the camera delivers high-quality monitoring images even in environments with low lighting, and provides back-end applications with round the clock, state-of-the-art data services. It supports a variety of AI functions for improved detection accuracy through its built-in neural network processor and is compatible with solar power supplies, meeting the heavy demands of long working hours.

The camera features behavior detection such as tripwire and intrusion, and multiple types of alarm linkage actions such as white light warning, audio playing and target tracking. To facilitate monitoring and analysis, it also features target filtering, face detection, and foreign object detection, and supports 4G network transmission and waking up from sleep mode.

### Features

#### Integrated Aluminum Die Casting Casing

Compact structure integrated with solar panel, lithium battery pack and charging controller to improve the appearance, installation, and maintenance of the System.

#### • Solar Power System

- Integrated design, easy to install
- Pole mount
- Angle flexible adjustment of solar panel and camera mount
- 125W monocrystalline solar panel
- Aluminum alloy frame
- Built sturdy to resist storms with sustained winds up to 117 km/h
- Remote monitoring available through the mobile app
- Maximum Power Point Tracking (MPPT) charging controller
- RS-485 communication function
- Electric protection

#### • 4G Network PTZ Camera

- 1/2.8" 4Megapixel STARVIS™ CMOS
- 32x optical zoom
- Starlight technology
- Max. 25/30 fps@1080p
- IR distance up to 150 m
- Auto-tracking
- Perimeter protection
- Face detection
- 4G
- Sound and light alarm
- Low power consumption



#### Monocrystalline Solar Panel

Adopts monocrystalline solar panel to greatly improve optical absorbance efficiency and power generation performance with dusky light.

#### Remote Monitoring with APP

With Dahua cameras, it supports real-time remote monitoring of the system operation status and alarm prompts of battery with APP.

#### Maximum Power Point Tracking Charging Controller (MPPT)

MPPT controller helps significantly improve the energy utilization efficiency of the System, and raise the charging efficiency by 10%–30% compared with conventional PWM controller.

**RS-485 Port**

RS-485 port and standard Modbus protocol, meeting communication requirements in various scenarios.

**Electronic Protection**

Comprehensive electronic protection: Current limiting, short circuit, and reverse current protection of solar panel; reverse connection, overvoltage, over-discharge, and over-temperature protection of lithium battery; overload and short circuit protection of load.

**Perimeter Protection**

Automatically filters out false alarms caused by animals, rustling leaves, bright lights, etc. Enables system to act secondary recognition for the targets. Improves alarm accuracy.

**Protection (IP66, Wide Voltage)**

IP66; TVS 6000V lightning proof; surge protection; voltage transient protection. Wide voltage: The camera allows -10% to +25% input voltage tolerance (wide voltage range), and it is widely applied to outdoor environment with instable voltage.

**Siren and Light Active Deterrence**

With up to 13 customizable audio files and a built in speaker, this camera is dynamic. It supports alarm linkages such as white light warning, audio playing and target tracking.

**Smart H.265+ & Smart H.264+**

With advanced scene-adaptive rate control algorithm, Dahua smart encoding technology realizes the higher encoding efficiency than H.265 and H.264, provides high-quality video, and reduces the cost of storage and transmission.

**PFA Technology**

PFA technology has innovatively introduced new methods of judgment to ensure the accuracy and predictability of the direction of subject distance adjustment. The result is a set of advanced focusing algorithms. PFA ensures clarity of the image throughout the process of zooming and shortens focus time. The realization of PFA technology substantially improves user experience and increases product value.

**Technical Specification****Integrated Solar Power System (Without Lithium Battery)**

Model	DH-PFM378-B125-CB
-------	-------------------

**Solar Panel**

Type	Monocrystalline silicon
Max. Power	125 W
Solar Cell Efficiency	21%
Max. Mechanical Load	5400 Pa

**Controller**

Type	MPPT
Operating Voltage	12 VDC
Rated Charging Current	10 A
Rated discharge current	10 A
MPPT Tracking Efficiency	≥ 99%
Communication Mode	RS485
Operating Temperature	-20 °C to +60 °C (-4 °F to +140 °F)
Rated Charging Power	130 W
Over-discharge Protection Voltage	11.1 VDC
Others	Over-temperature ,over-discharge,overa-voltage and low-temperature protection of battery; overload and short circuit protection of load.

**Port**

Power Output	Φ5.5 mm × Φ2.1 mm × 12 mm (Φ0.22" × Φ0.08" × 0.47")
RS-485	Red: RS485-A Black: RS485-B
Output Port	CSA authorized M15 2-core waterproof connector (connected to lithium battery)

**General**

Main Body Material	Q235 steel/aluminum
IP Rating	IP65
Installation	Pole mount, Φ80mm~Φ150mm
Adjustable Angle	Solar panel: H: 360°, V: 10°/20°/30°/40°/50°
Product Dimensions	965.0 mm × 910.5 mm × 786.4 mm (37.99" × 35.85" × 30.96")
Packaging Dimensions	1,280 mm × 775 mm × 280 mm (50.39" × 30.51" × 11.02")
Packaging Method	1 pc in each carton
Net Weight	20.1 kg (44.31 lb)
Gross Weight	26 kg (57.32 lb)

**Environment**

Operating Altitude	< 3000 m (9842.5 ft)
Applicable Area	Areas with daily exposure to solar radiation for more than 3.5 hours
Operating Temperature	-20 °C to +60 °C (-4 °F to +140 °F)
Operating Humidity	< 95% (RH)
Storage Temperature	0 °C to +40 °C (+32 °F to +104 °F)
Storage Humidity	< 95% (RH)

**Certifications**

Certifications	CE: EN 55032: 2015+A11: 2020, EN 55030-4: 2011+A1: 2014, EN 55024: 2010+A1: 2015, EN 55035: 2017+A11: 2020 FCC: 47 CFR Part 15, Subpart B UKCA: EN 55032: 2015+A11: 2020, EN 55030-4: 2011+A1: 2014, EN 55024: 2010+A1: 2015, EN 55035: 2017+A11: 2020
----------------	--

**4 MP 32x Startlight IR WizSense Network PTZ Camera**

Model	DH-SD6C3432XB-HNR-AGQ-PV
-------	--------------------------

**Camera**

Image Sensor	1/2.8" CMOS
Pixel	4 MP
Max. Resolution	2560 (H) × 1440 (V)
ROM	4 GB
RAM	1 GB
Electronic Shutter Speed	1/1 s–1/30,000 s
Scanning System	Progressive
Min. Illumination	Color: 0.005 lux@F1.6 B/W: 0.0005 lux@F1.6 0 lux (IR light on)
Illumination Distance	150 m (492.13 ft) (IR) 80 m (262.47 ft) (white light)
Illuminator Number	4 (IR) 2 (white light)

**Lens**

Focal Length	4.8 mm–154 mm			
Max. Aperture	F1.6–F4.0			
Field of View	H: 55.8°–2.3° V: 31.9°–1.3° D: 63.7°–2.7°			
Optical Zoom	32×			
Focus Control	Auto; Semi-Auto; Manual			
Close Focus Distance	0.1m-1.5m			
Iris Control	Auto			
DORI Distance	Detect	Observe	Recognize	Identify
	3,080 m (10104.99 ft)	1,216.6 m (3991.47 ft)	616 m (2021.00 ft)	308 m (1010.50 ft)

**PTZ**

Pan/Tilt Range	Pan: 0° to 360° endless Tilt: –20° to +90°, auto flip 180°
Manual Control Speed	Pan: 0.1°–160°/s; Tilt: 0.1°–120°/s
Preset Speed	Pan: 240°/s; Tilt: 150°/s
Preset	300
Tour	8 (up to 32 presets per tour)
Pattern	5
Scan	5
Power-off Memory	Yes
Idle Motion	Preset; Pattern; Tour; Scan

**Smart Event**

IVS	Tripwire; intrusion; crossing fence detection; loitering detection; abandoned/missing object; fast moving; parking detection; people gathering; linkage tracking
-----	--

**Intelligence**

Smart Capture	Support human, motor vehicle and non-motor vehicle image capture.
IVS (Perimeter Protection)	Tripwire and intrusion. Support alarm triggering by target types (human and vehicle). Support filtering false alarms caused by animals, rustling leaves, bright lights, etc.
Face Detection	Yes
People Counting	Yes
Auto Tracking	Preset; Pattern; Tour; Scan

**Video**

Video Compression	Smart H.265+; H.265; Smart H.264+; H.264B; H.264M; H.264H; MJPEG (Sub Stream)
Streaming Capability	3 streams
Resolution	4M (2560 × 1440); 3M (2048 × 1536); 1080p (1920 × 1080); 1.3M (1280 × 960); 720p (1280 × 720); D1 (704 × 576); CIF (352 × 288)
Video Frame Rate	Main stream: 4M/3M/1080p/1.3M/720p (1–50/60 fps) Sub stream 1: D1/CIF (1–25/30 fps) Sub stream 2: 1080p/1.3M/720p (1–25/30 fps)
Bit Rate Control	CBR/VBR
Video Bit Rate	H.264: 2816 kbps–8192 kbps H.265: 1024 kbps–7936 kbps
Day/Night	Auto (ICR); Color; B/W
BLC	Yes
HLC	Yes
White Balance	Auto; indoor; outdoor; tracking; manual; sodium lamp; natural light; street lamp
Gain Control	Auto; manual
Noise Reduction	2D NR; 3D NR
Region of Interest (RoI)	Yes
Image Stabilization	EIS
Defog	Electronic defog
Digital Zoom	16 ×
Privacy Masking	Up to 24 areas can be set, with up to 8 areas in the same view
S/N Ratio	≥ 55 dB

**Audio**

Audio Compression	G.711a; G.711Mu; G.726; AAC; MPEG2-Layer2; G722.1; G729; G723
-------------------	---

**Network**

Network Port	RJ-45 (10/100 Base-T)
4G-Wireless Frequency Range	LTE-FDD: B1/3/5/7/8/20 LTE-TDD: Band 38/40 WCDMA: Band 1/5/8 GSM: 850/900/1800 MHz
Network Protocol	HTTP; HTTPS; TCP/IP; IPv4; RTSP; UDP; SMTP; NTP; DHCP; DNS; DDNS; IPv6; 802.1x; SSL; QoS; FTP; UPnP; ICMP; SNMP; SNMP v1/v2c/v3 (MIB-2); IGMP; ARP; RTP; RTCP; RTP; PPPoE; IP Filter; RTMP; Bonjour; TCP; SMB; NFS

Interoperability	ONVIF (Profile S&G&T); CGI; Dahua SDK; GA/T 1400; SDK; API
User/Host	20 (total bandwidth: 64 MB)
Storage	FTP; Micro SD card (256 GB); NAS
Management Software	Smart PSS; DSS; DMSS; Easy4ip; IVSS; ConfigTool; NVR; Smart Player; Imou; NetSDK
Mobile Client	iOS; Android; iPhone; iPad; Windows Phone

**Certification**

Certifications	CE: EN55032/EN55024/EN50130-4 FCC: Part15 subpartB, ANSI C63.4-2014
----------------	--

**Port**

RS-485	1 (baud rate: 1200 bps–9600 bps)
Two-way Audio	Yes
Alarm Linkage	Capture; preset; tour; pattern; recording; triggering on-off value output; audio; sending email; waking up
Alarm Event	Motion/tampering detection; audio detection; network disconnection detection; IP conflict detection; memory card state detection; memory space detection; power exception detection
Alarm I/O	2/1
Audio I/O	1/1

**Power**

Power Supply	12 VDC, 4 A (–10% to +25%)
Power Consumption	Sleep: ≤ 1 W Basic: 4.0 W (not pulling stream in 4G), 7.4 (pulling stream in 4G) Max.: 27 W (illuminator+heater+PTZ+speaker+pulling stream in 4G)

**Environment**

Operating Temperature	–40 °C to +70 °C (–40 °F to +158 °F)
Operating Humidity	≤ 95%
Protection	IP66, TVS 6000 V lightning proof; surge protection; voltage transient protection

**Structure**

Casing	ADC12
Dimensions	325.0 mm × Φ202.0 mm (12.80" × Φ7.95")
Net Weight	4.4 kg (9.70 lb)
Gross Weight	6.4 kg (14.11 lb)

**Ceiling Mount Bracket of PTZ camera**

Model	DH-PFB301C
-------	------------

**General**

Material	Aluminum alloy
Dimension (W×H×D)	Φ128.8 mm × 35.5 mm (5.07" × 1.40") (D × H)
Weight	0.21 kg (0.46 lb)
Load Bearing	10.0 kg (22.04 lb)

**Mount Adapter**

Model	PFA111
-------	--------

**General**

Material	Aluminum
Dimension (W×H×D)	Φ60 mm × 49 mm (Φ2.36" × 1.93")
Weight	0.25 kg (0.55 lb)
Load Bearing	7.0 kg (15.43 lb)

**Ordering Information**

Type	Model	Description
Solar Series	KIT/DH-PFM378-B125-CB/DH-SD6C3432XB-HNR-AGQ-PV/DH-PFB301C/PFA111	KIT: 125 W integrated solar power system (Without Lithium Battery) /4G Network PTZ Camera/DH-PFB301C/PFA111
Accessories (Optional)	PFM372-L45-4S14P	Integrated Solar lithium Battery

**Dimensions (mm[inch])**

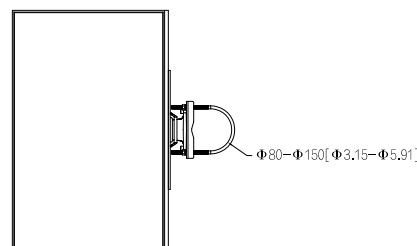
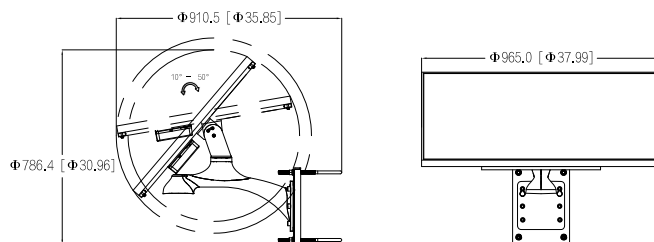

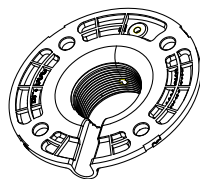
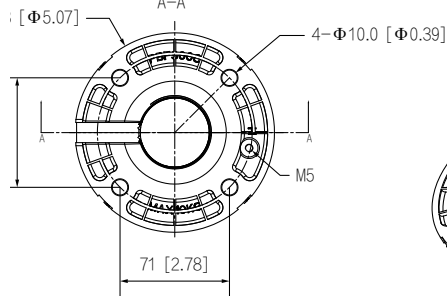
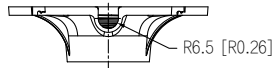
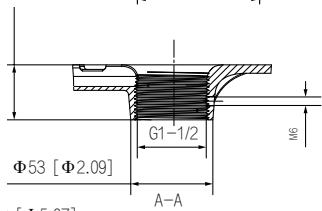
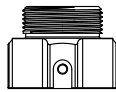
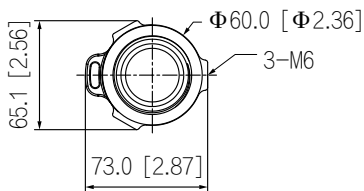
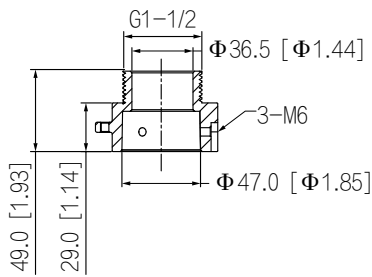
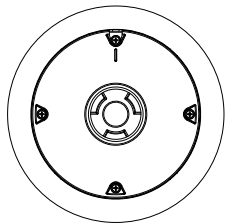
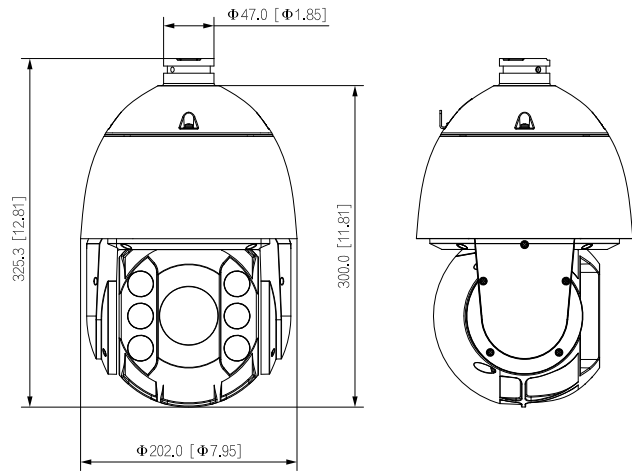

## Accessories

Optional:



PFM372-L45-4S14P  
Integrated Solar  
lithium Battery

## Application

